

PLANTAS BARRAGEM

CÓRREGO AREIÃO

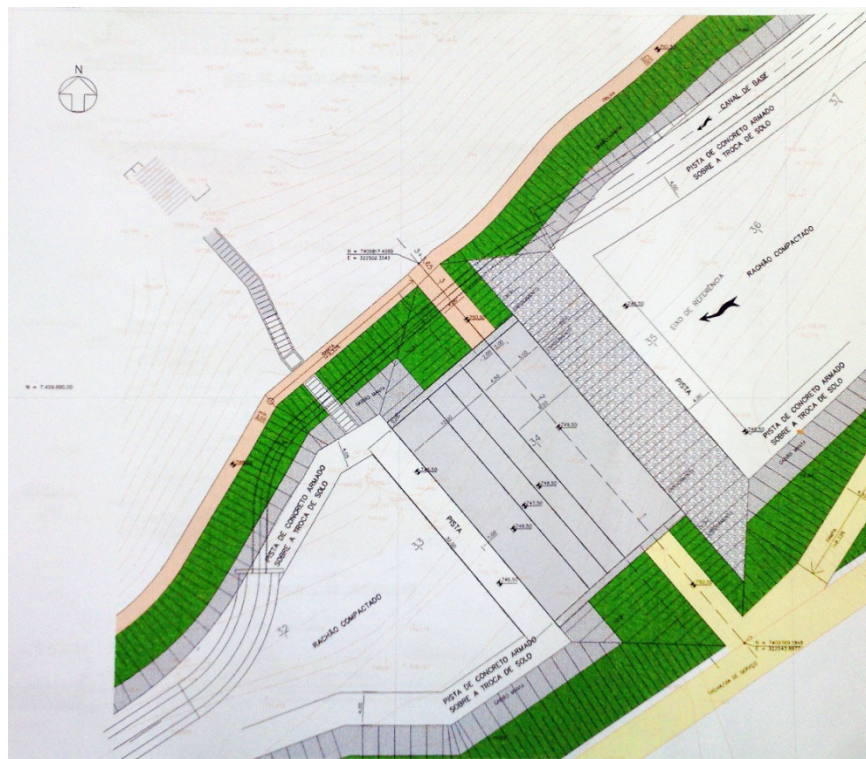

PLANTA BARRAGEM 1 - s/escala



PLANTA BARRAGEM 2 - s/escala

IMPLANTAÇÃO

NÚCLEO 2 - JUNÇÃO

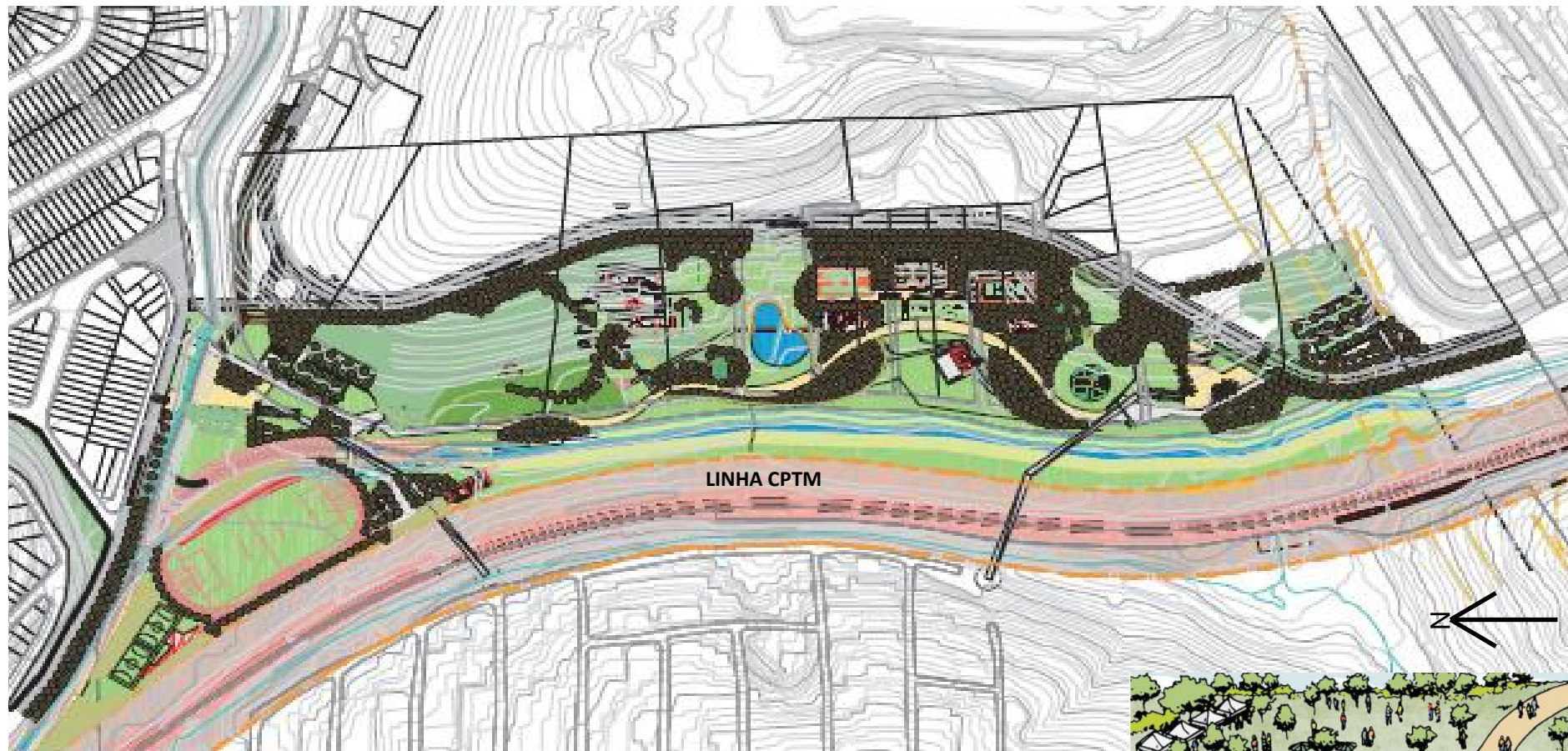

- ÁREAS RECREATIVAS
- EQUIP. ATIV. ESPORTIVAS
- ÁREAS DE LAZER
- LAGO

- ESTACIONAMENTO
- PASSARELAS – TRANSP. VIA FÉRREA
- APOIO ADM.
- VESTIÁRIOS
- ESCOLA AMBIENTAL



CORTE GERAL

NÚCLEO 2 - JUNÇÃO

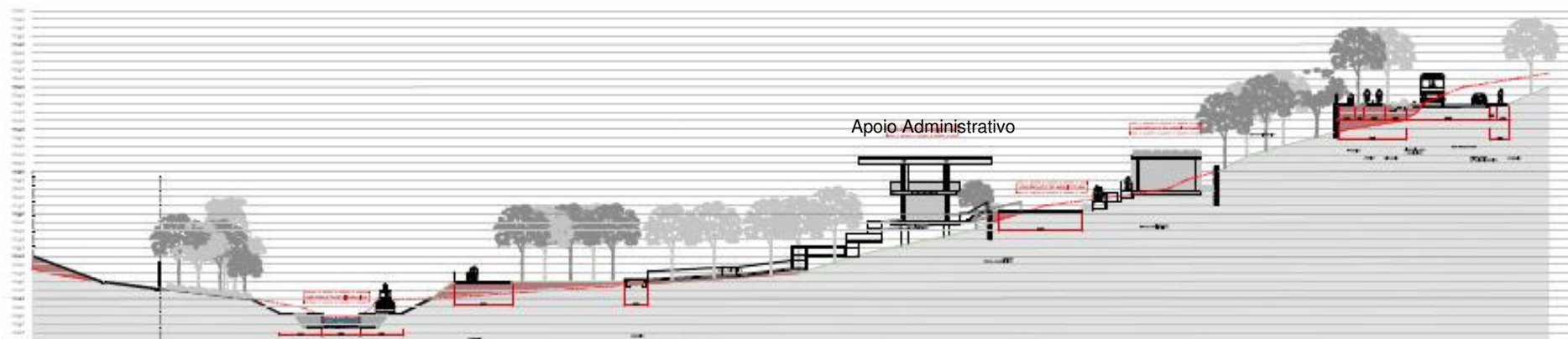

CORTE GERAL córrego

s/escala

IMPLANTAÇÃO

NÚCLEO 3 - RESERVA

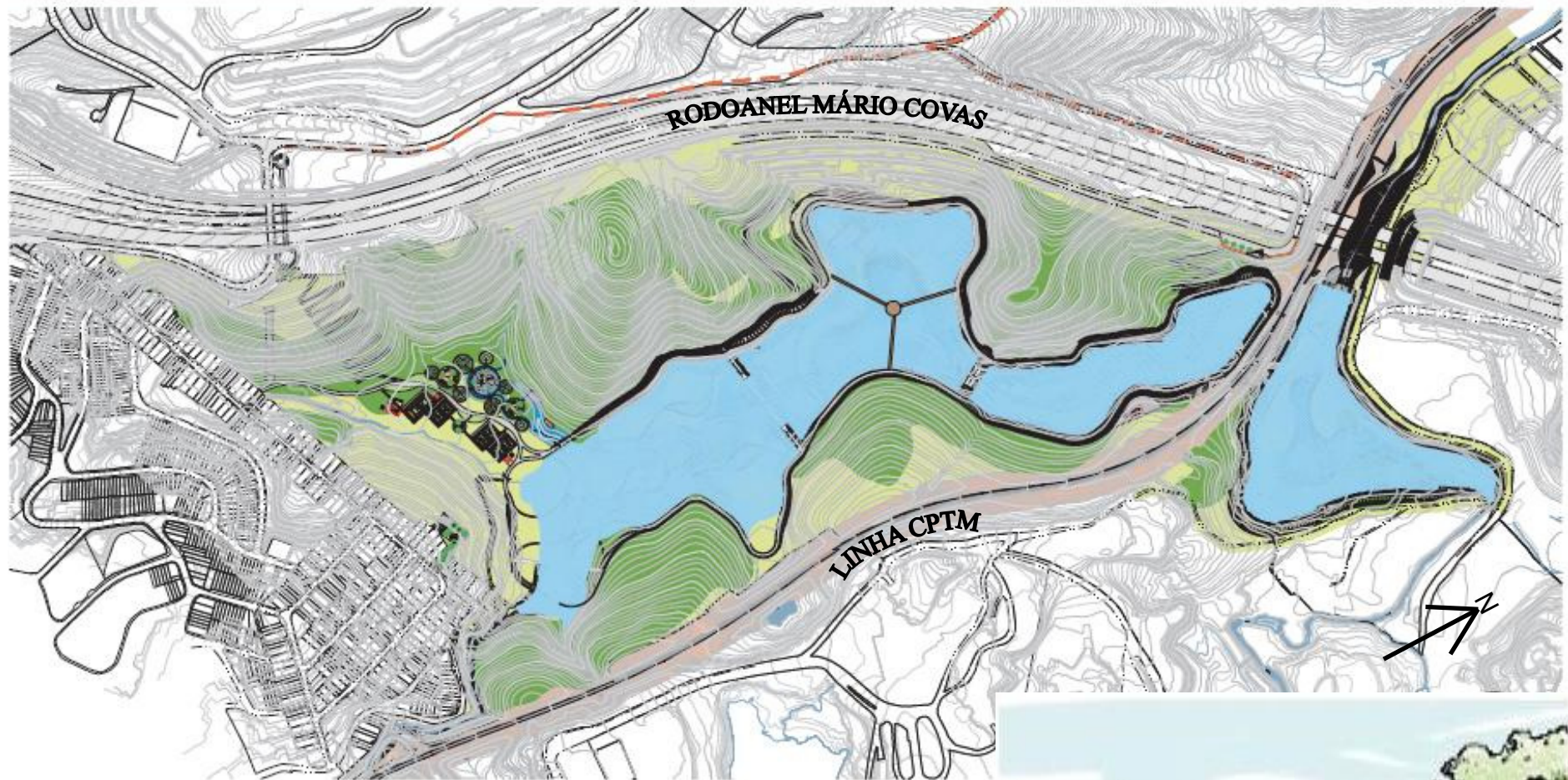

- VESTIÁRIOS
- APOIO ADMINISTRATIVO
- ÁREA PARA VIVEIRO DE PLANTAS
- EQUIPAMENTOS ESPORTIVOS
- ÁREA RECREATIVA



CORTE GERAL

NÚCLEO 3 - RESERVA

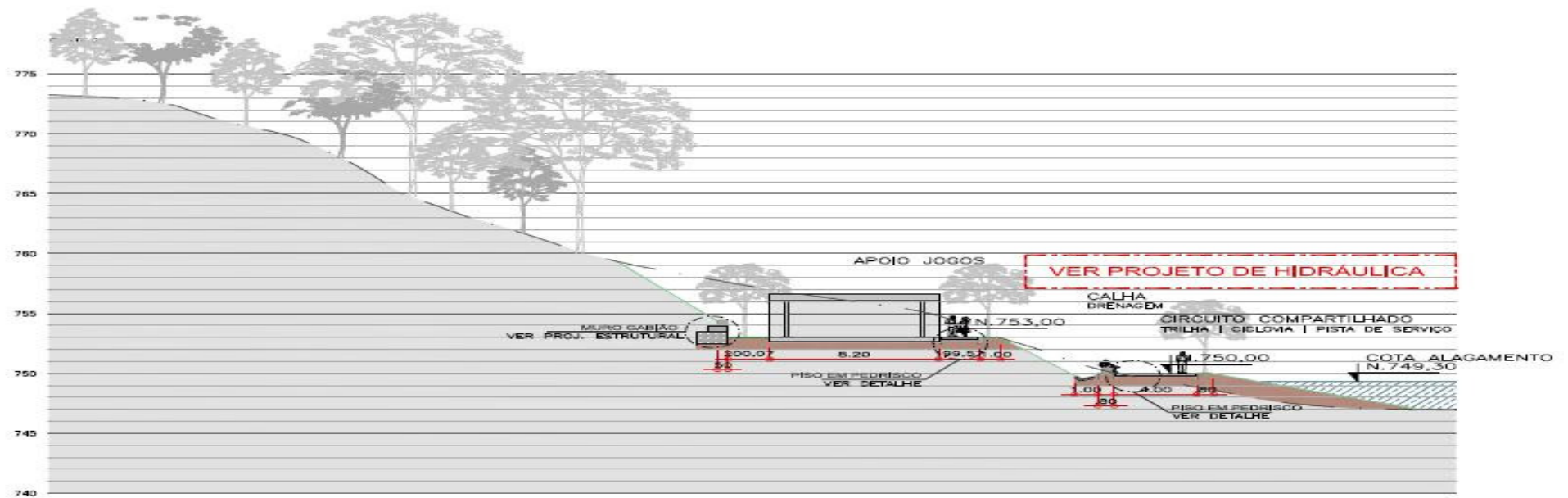

CORTE GERAL

s/escala

RESERVATÓRIOS

NÚCLEO 3 - RESERVA

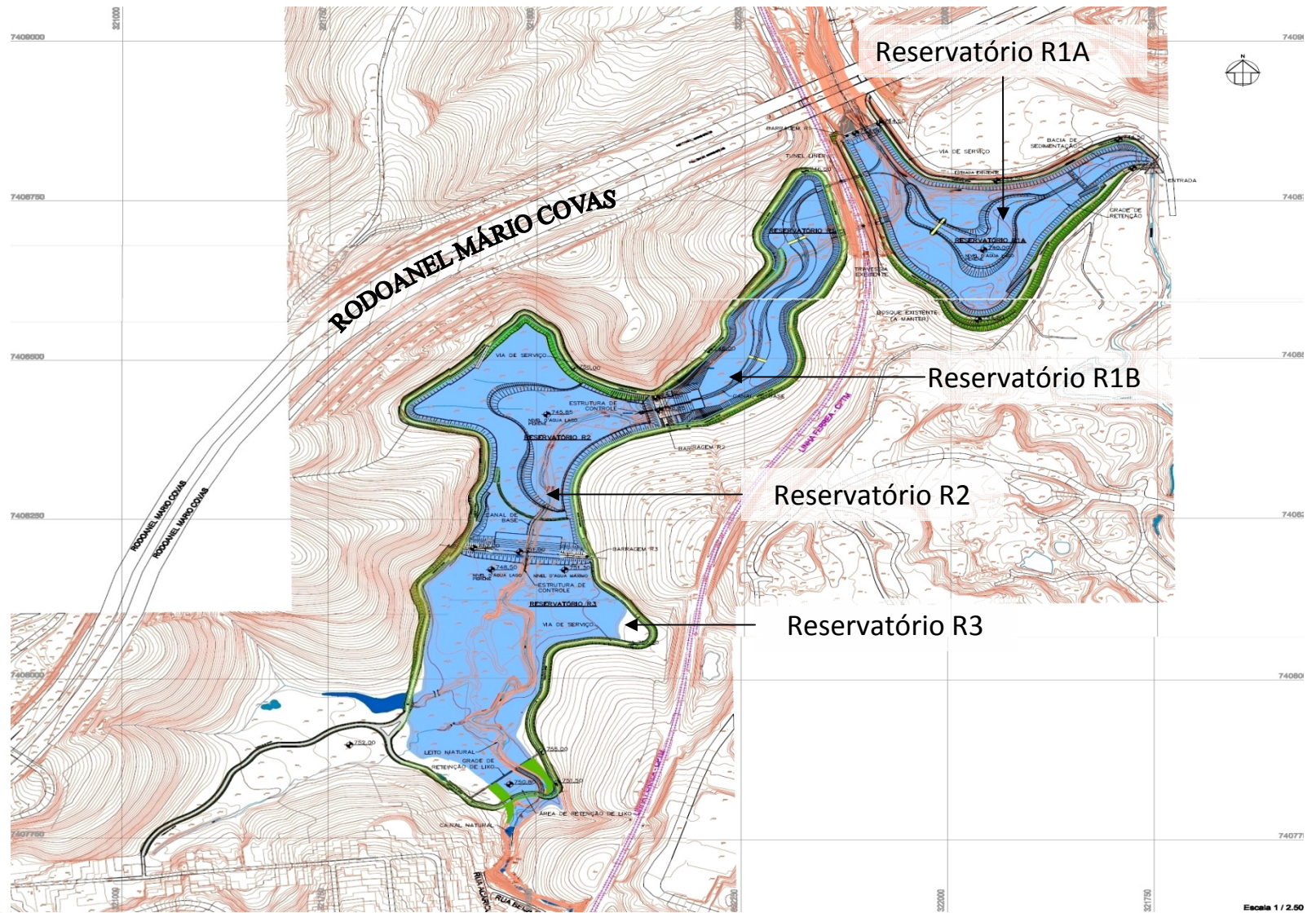

RESERVATÓRIO R1A

NÚCLEO 3 - RESERVA

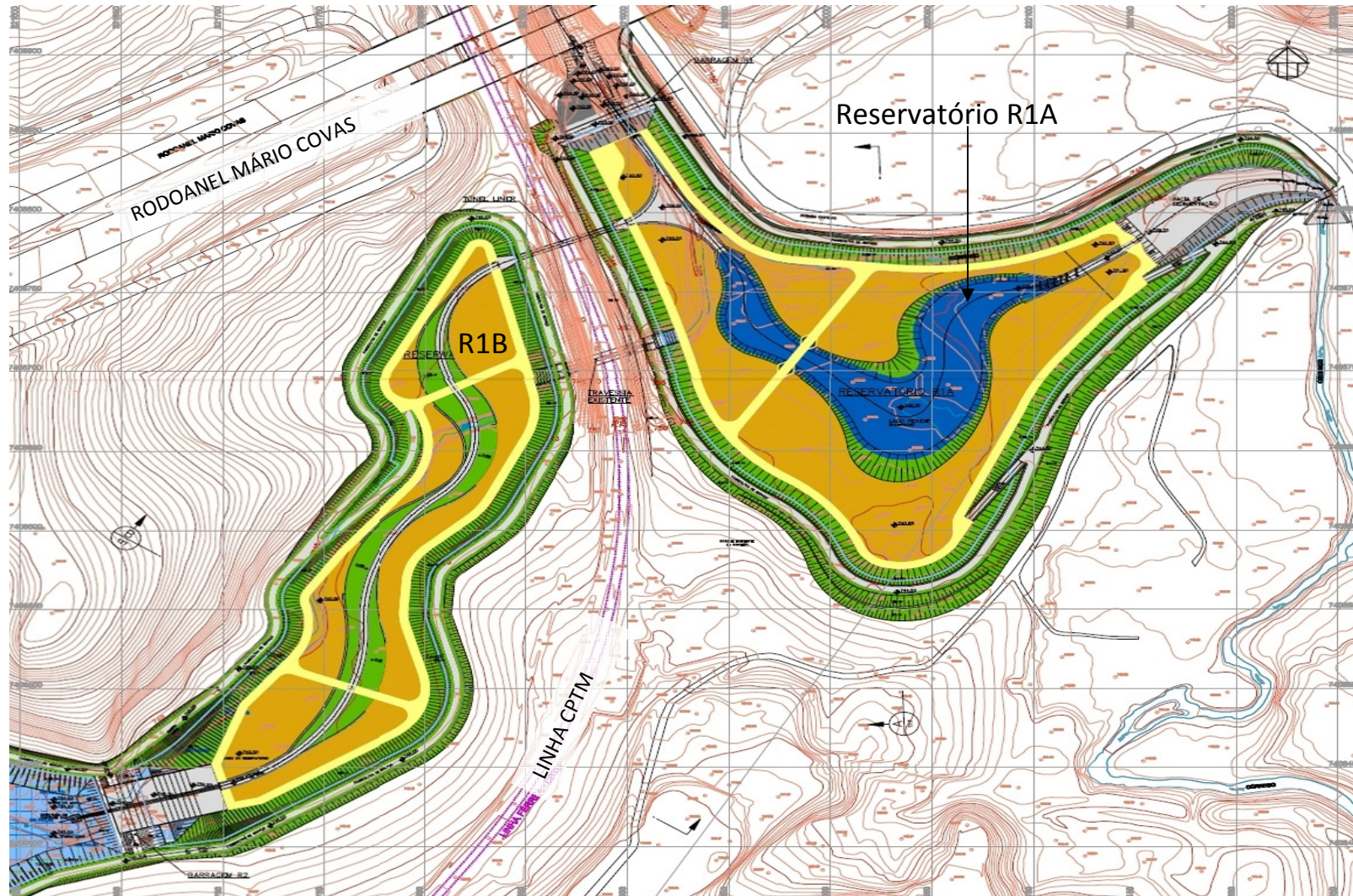

RESERVATÓRIO R1A

NÚCLEO 3 - RESERVA

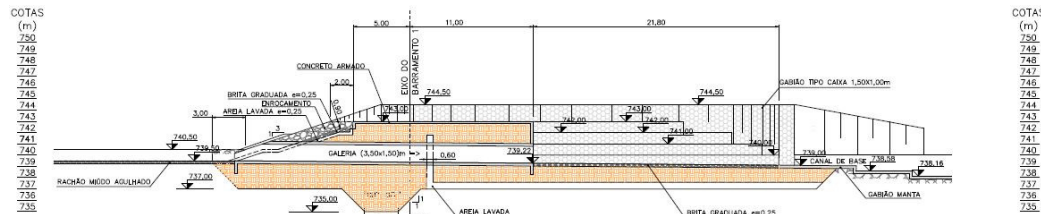
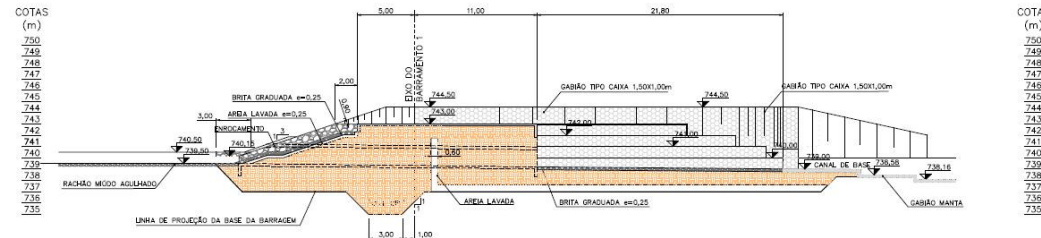
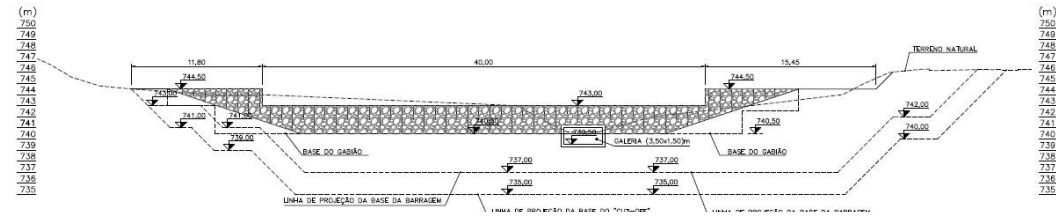
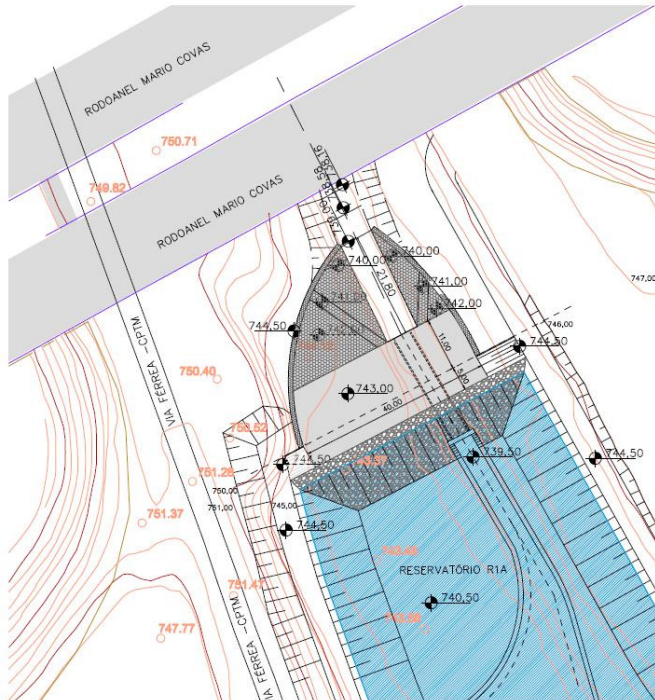

RESERVATÓRIO

INTERLIGAÇÃO ENTRE OS RESERV. R1A e R1B

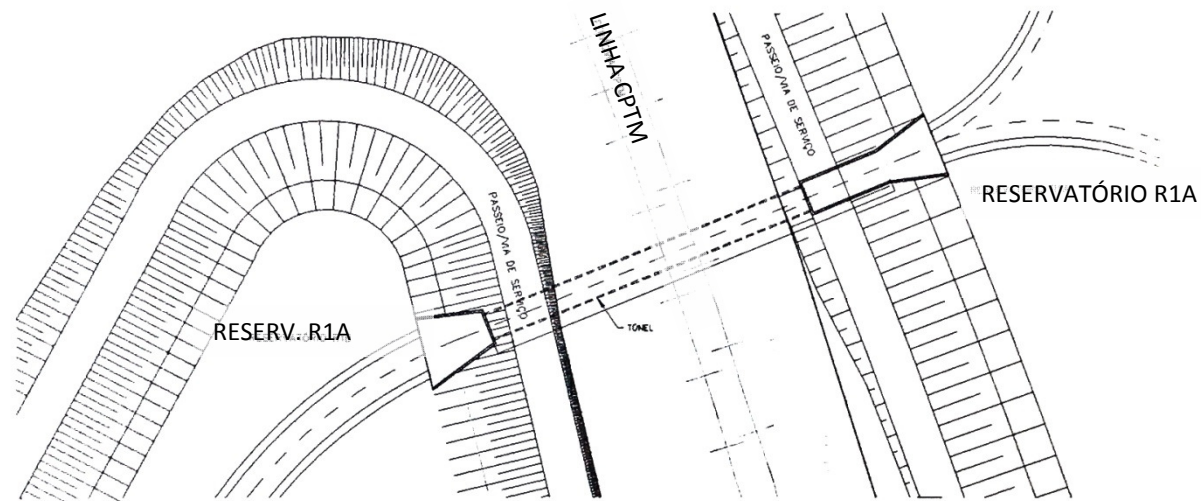

PLANTA TÚNEL LINEAR - s/escala

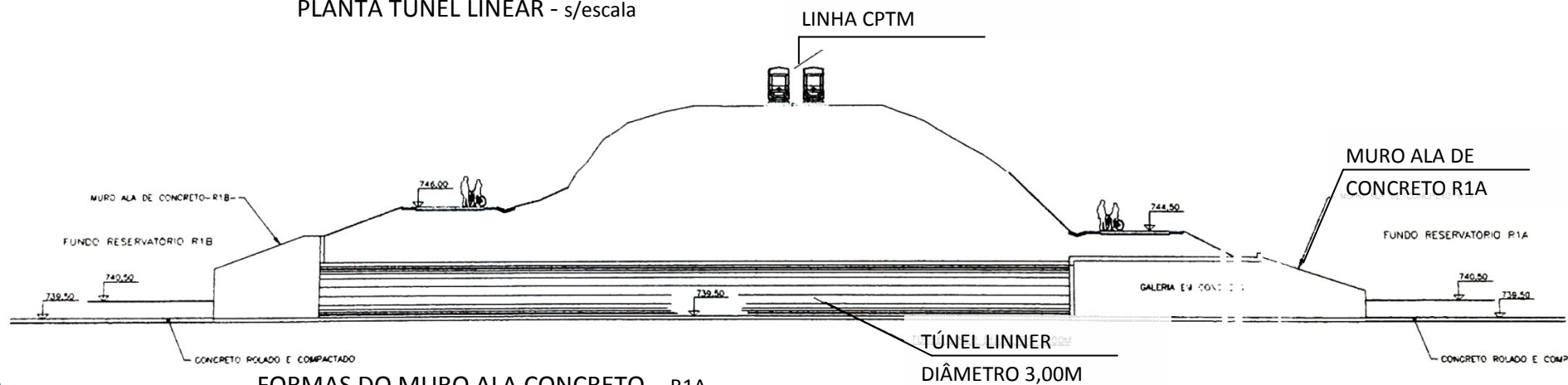

FORMAS DO MURO ALA CONCRETO – R1A

TÚNEL LINNER
DIÂMETRO 3,00M

RESERVATÓRIO

INTERLIGAÇÃO ENTRE OS RESERV. R1A e R1B

FORMAS DO MURO ALA CONCRETO-R1A

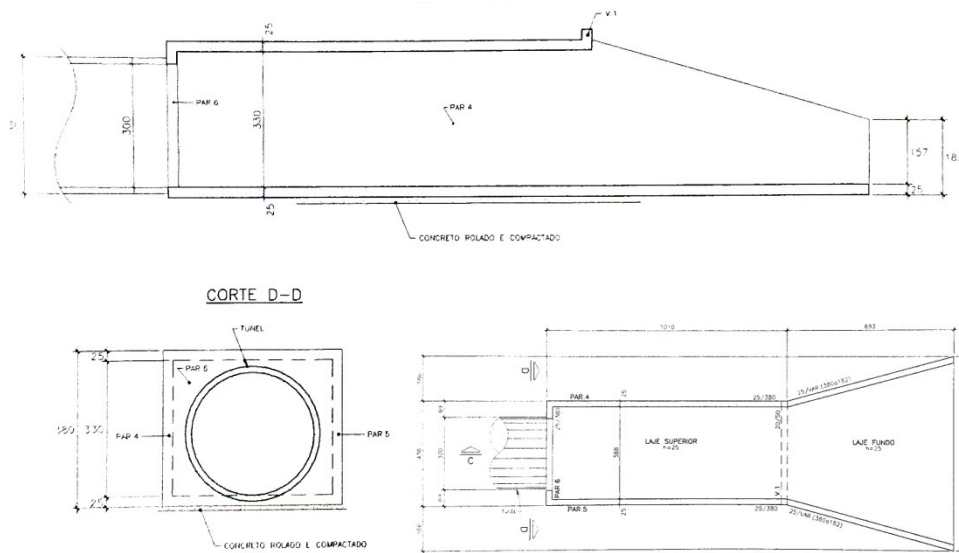

FORMAS DO MURO ALA CONCRETO-R1B

