

LARGO DA BATATA

Maio de 2015





BICICLETÁRIO



Contagem de ciclistas na Faria Lima

| Antes | | abr/14 | | | |
|--------------|---------|------------------|-------------------|------------|---------------------|
| Horário | Período | Total bicicletas | Bicicletas comuns | Bike share | Bicicletas de carga |
| 7:00-10:00 | Manhã | 238 | 189 | 18 | 31 |
| 16:00-19:00 | Tarde | 237 | 211 | 16 | 10 |
| Total | | 475 | 400 | 34 | 41 |

| Depois | | mar/15 | | | |
|--------------|---------|------------------|-------------------|------------|---------------------|
| Horário | Período | Total bicicletas | Bicicletas comuns | Bike share | Bicicletas de carga |
| 7:00-10:00 | manhã | 344 | 281 | 23 | 40 |
| 16:00-19:00 | tarde | 394 | 316 | 64 | 14 |
| Total | | 738 | 597 | 87 | 54 |

| Comparação | | Total bicicletas | Bicicletas comuns | Bike share | Bicicletas de carga |
|----------------------|---------------|------------------|-------------------|------------|---------------------|
| Diferença (%) | 55,37% | | 49,25% | 155,88% | 31,71% |

Duração do estacionamento

- Curta duração (até 4h)
- Longa duração (de 4h a 24h)
- Longa duração (de 24h a 72h)

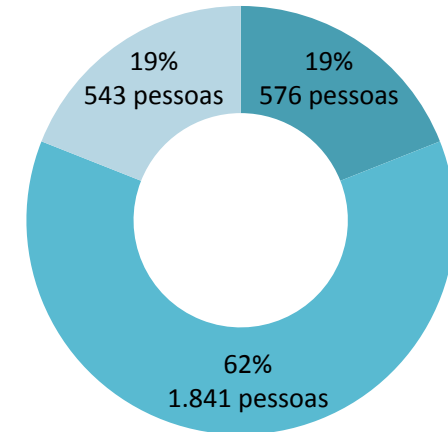

Frequência de Uso

- Dias da semana
- Finais de semana

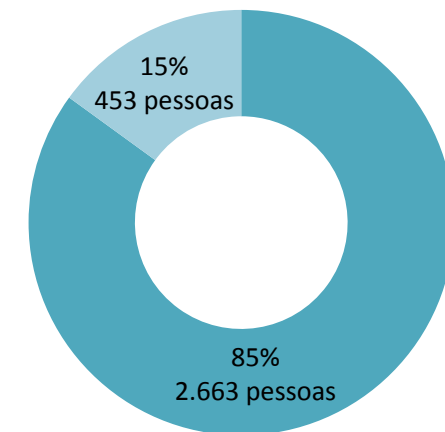

DIÁLOGO ABERTO
PROCESSO PARTICIPATIVO MORADORES E FREQUENTADORES



LARGO DA BATATA
MAPA DE ZONEAMENTO E PROGRAMA DE OCUPAÇÃO
 RESULTADO DAS OFICINAS REALIZADAS ENTRE MARÇO E DEZEMBRO DE 2014

1. ZONA IGREJA

Lazer para idosos e crianças pequenas.
 Espaço livre em frente à igreja.
 Preferencialmente para idosos e crianças pequenas (bancos com jogos, playground).
 Bancos fixos em volta das árvores
 Pergolado para sombra.
 Paracidos
 Bebedouro

2. PRAÇA CÍVICA

Eventos temporários em área central
 Jogos sem local fixo
 Bancos fixos em volta das árvores
 Paracidos
 Marquise ao longo da Rua Martin Carrasco, que se une a Cardenal Arcoverde na zona 5, generosa, abrindo para permanência em alguns trechos
 Wifi e tomadas
 Mobiliário portátil: mesas, cadeiras, guarda-sol, bancos, brinquedos.
 Pista de skate
 Floresiras (impedem passagem de carros, delimitam área dos bares)

3. ZONA METRÔ E BICICLETÁRIO

Circulação metrô e bicicletário
 Espaço de informação e comunicação
 Lazer e estar para jovens
 Mesa de ping-pong e outros jogos
 Bebedouro
 Banheiro público
 Bancos fixos em volta das árvores
 Tótem com informações nas estruturas do Metrô
 Bancos e mesas fixos
 Quiosques de comida de rua com mesinhas fixas
 Restaurantes Pop-Up
 Ponto de Táxi

4. ZONA EM FRENTE À "CAC"

Grande circulação de pedestres
 Área para exposições e comércio
 Feira orgânica
 Linha de painéis para exposição ao longo do tapume da CAC
 Paracidos
 Quiosques para comércio e livraria

5. ZONA ARAUCÁRIAS

Área de estar e descanso
 Área de lazer para adultos
 Bancos e mesas fixos
 Jogos para adultos
 Espaços de estar com mobiliário portátil
 Marquise no trecho da Rua Cardenal Arcoverde ligando à área 2, generosa, abrindo para permanência em alguns trechos.
 Passarela sem degraus passando por cima da Faria Lima
 Fonte lúdica
 Ludoteca

6. ZONA MERCADO

Área para esportes
 Área relacionada ao Mercado de Pinheiros (pode servir de apoio para eventos do Mercado)
 Tabelas de basquete
 Equipamentos portáteis para eventos culturais de pequeno porte
 Contêiner para guardar móveis portáteis
 Contêiner para base comunitária/zeladoria que também sejam apoio para associações da região
 Paracidos
 Banheiro público
 Mesas e bancos

7. CICLOVIA / CAANTEIRO CENTRAL

Melhoria do projeto de ciclovia particularmente nas áreas de travessa de pe-destres
 Corredor verde ao longo da ciclovia
 Conexão da ciclovia com a estação Pinheiros

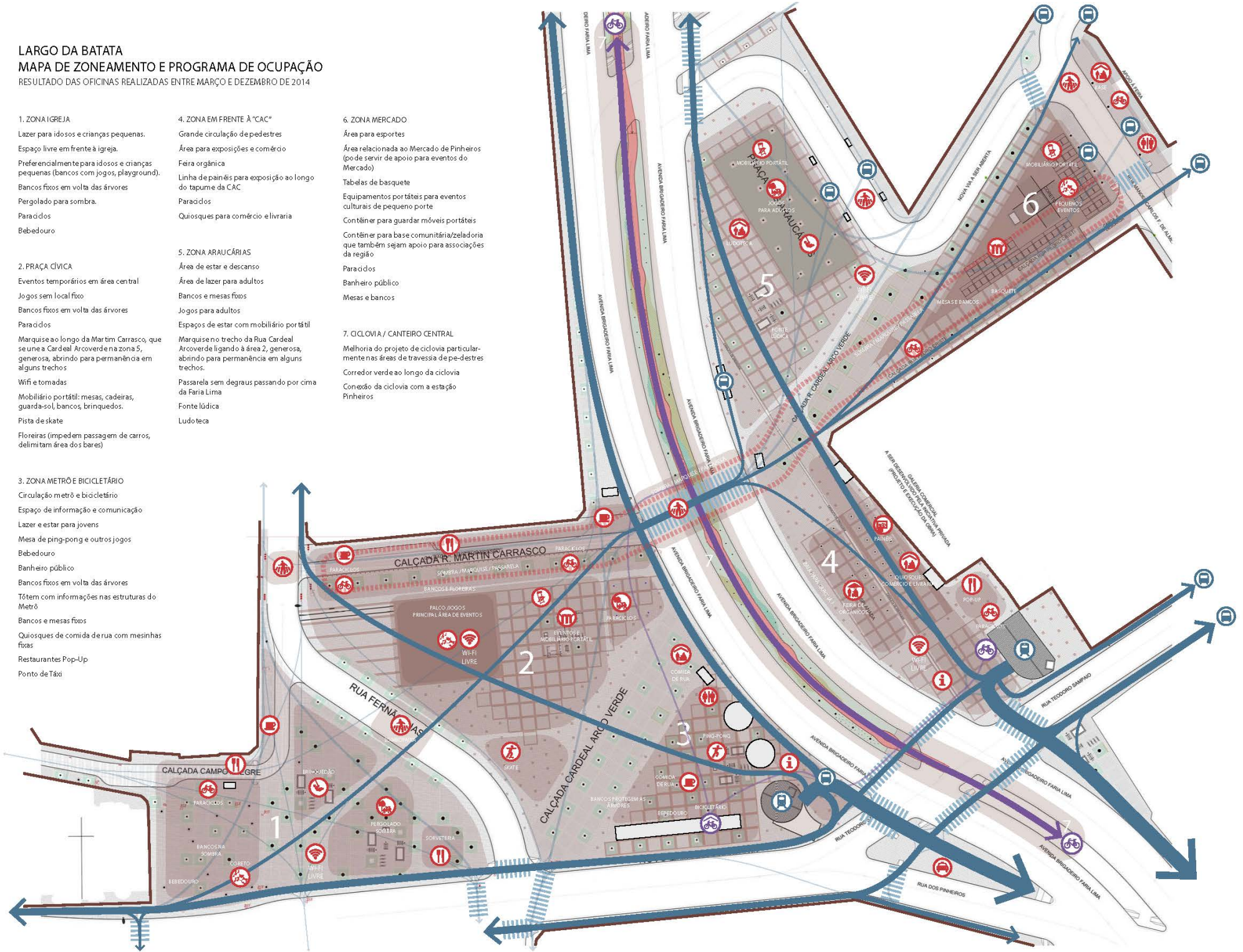

PROPOSTA SPURBANISMO



PÇA CÍVICA, ZONA METRÔ E BICICLETÁRIO

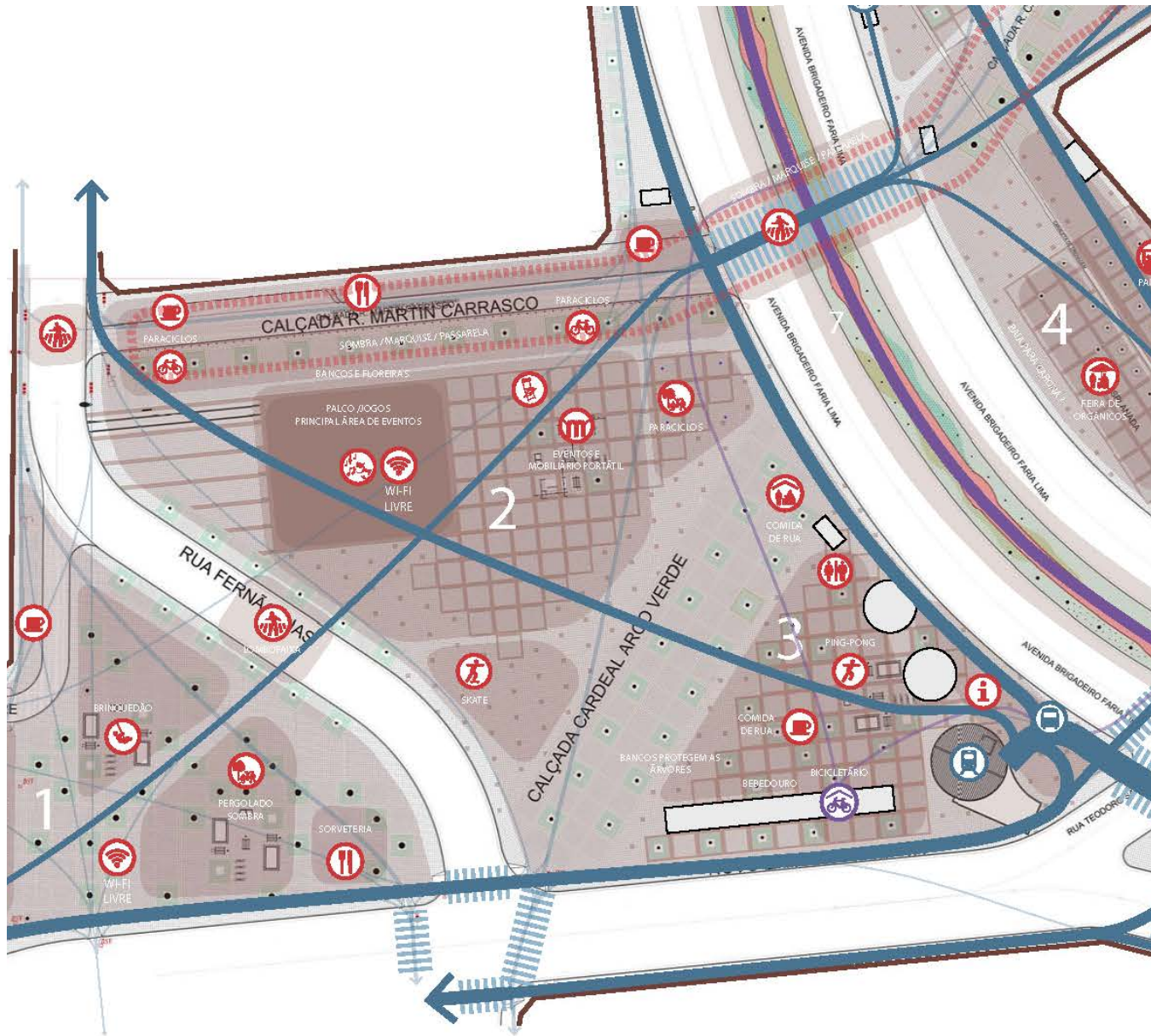

- Infraestrutura para eventos
- Bancos
- Mesas
- Mobiliário portátil

- Sombra
- Paraciclos
- Espaço para skate
- Controle de acesso para Martim Carrasco



PÇA CÍVICA, ZONA METRÔ E BICICLETÁRIO



PÇA CÍVICA, ZONA METRÔ E BICICLETÁRIO



PÇA CÍVICA, ZONA METRÔ E BICICLETÁRIO

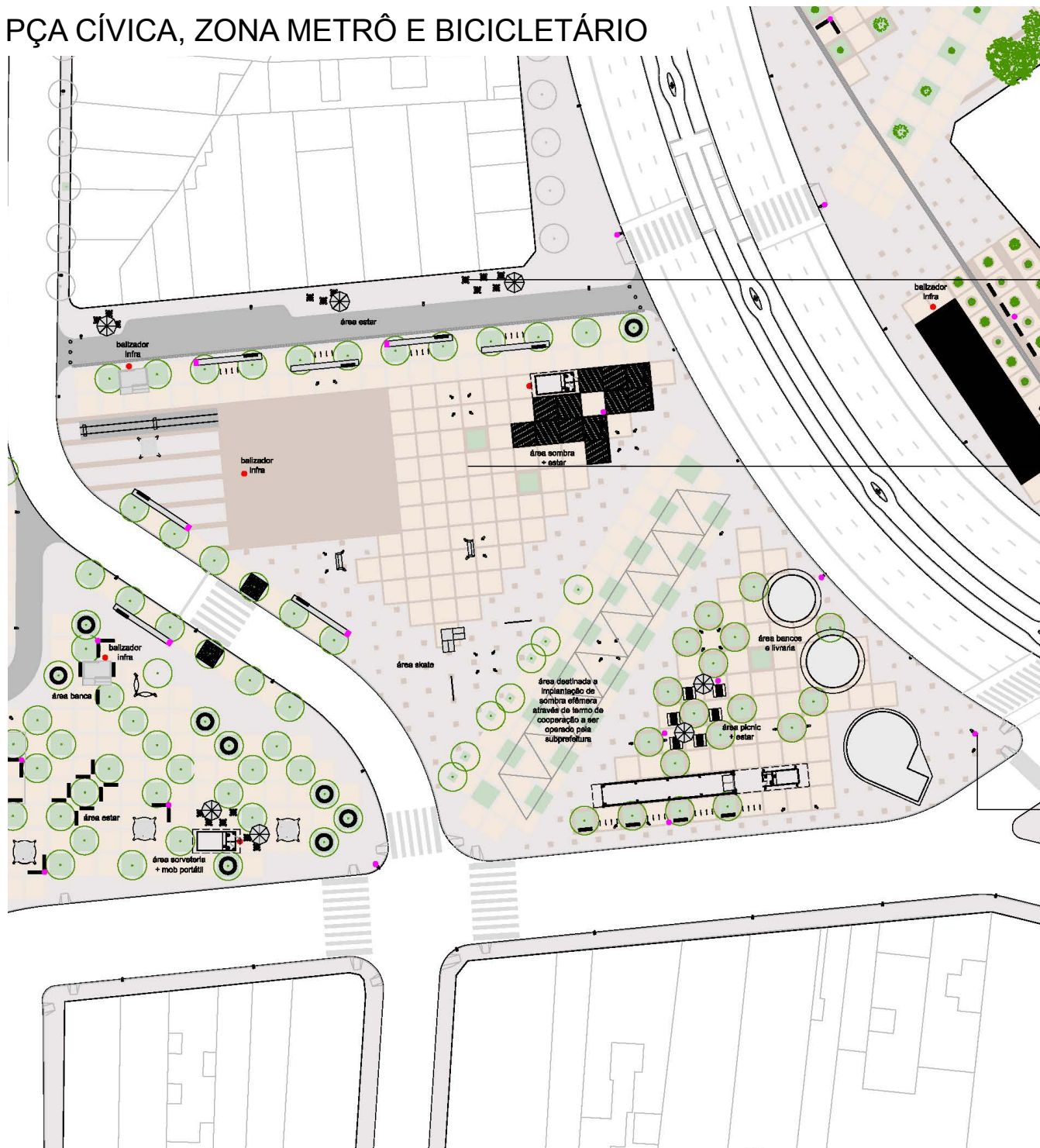

PÇA CÍVICA, ZONA METRÔ E BICICLETÁRIO

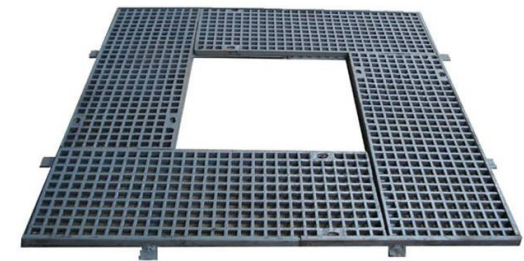

PERGOLADO



MÓDULO PARA PERGOLADO
PLANTA
ESCALA 1:50

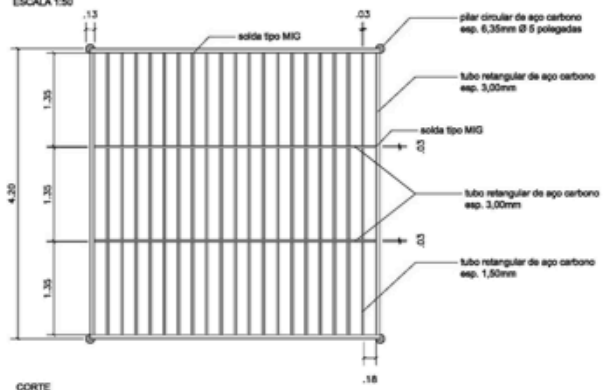

CORTE
ESCALA 1:50

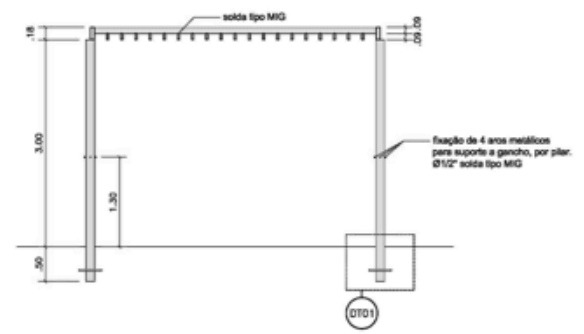

Exemplo de composição possível

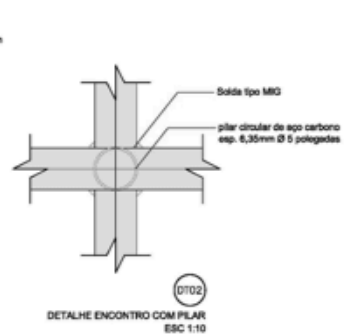
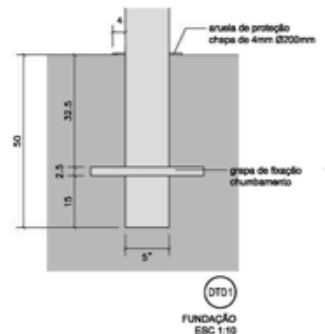
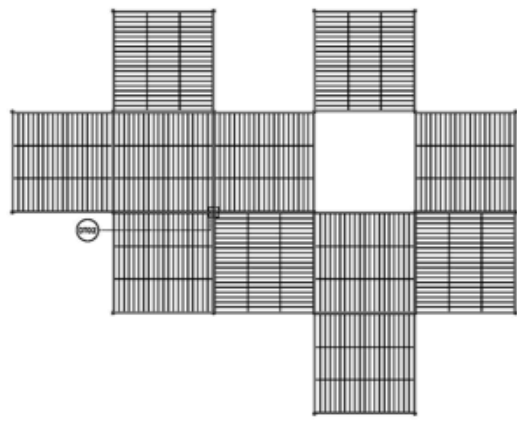

EQUIPAMENTOS PARA SKATE

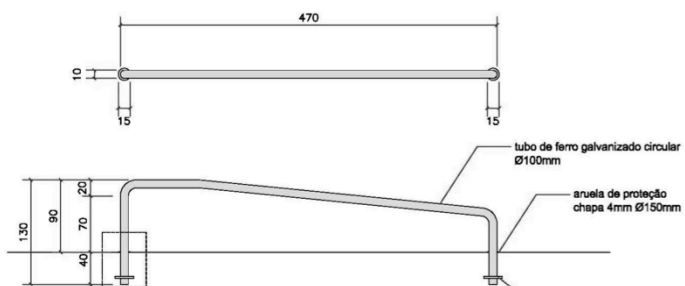
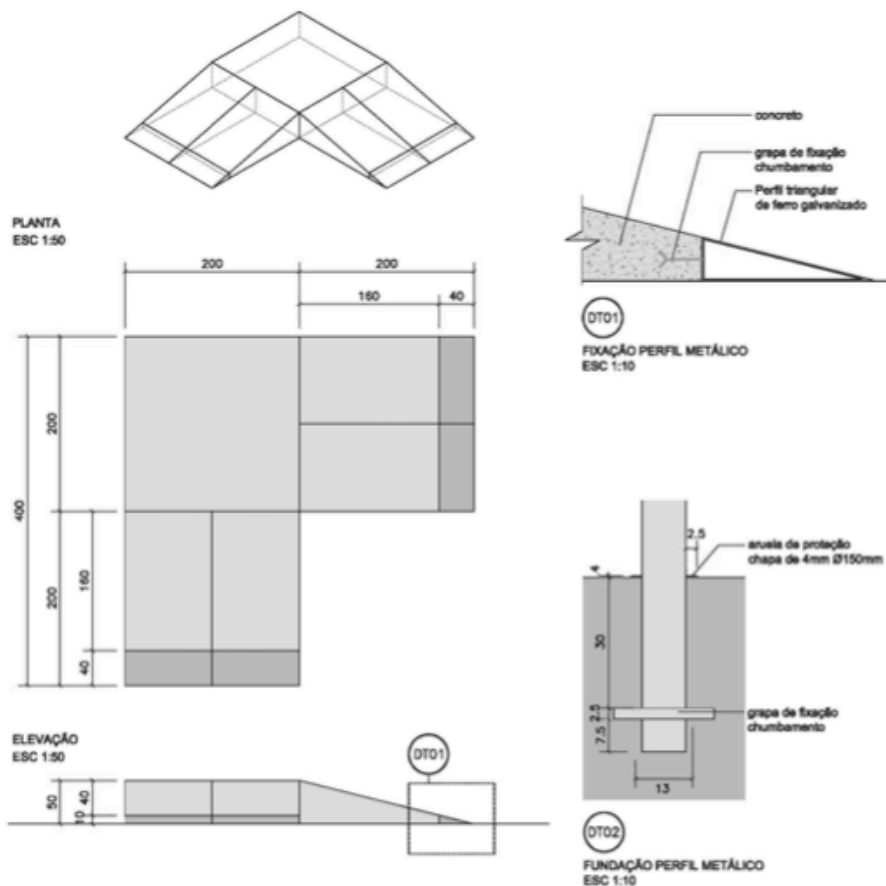

SUPORE PARA REDES

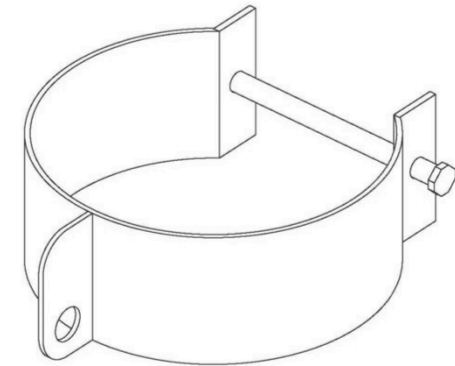
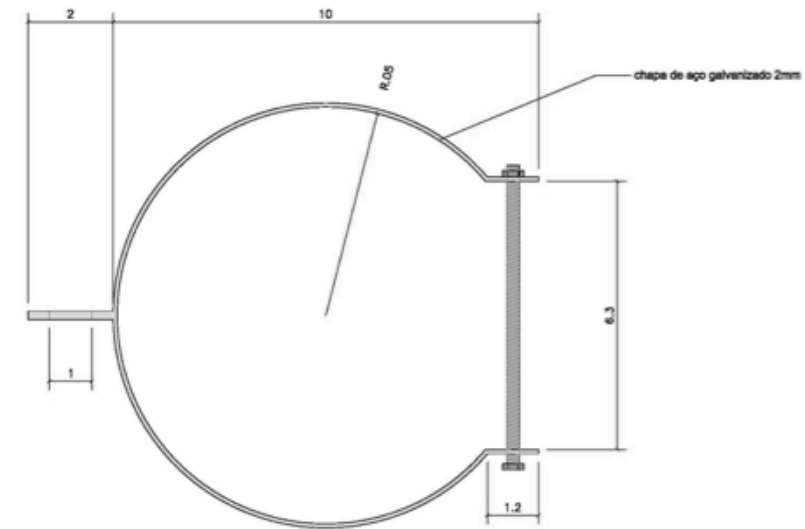

ZONA IGREJA

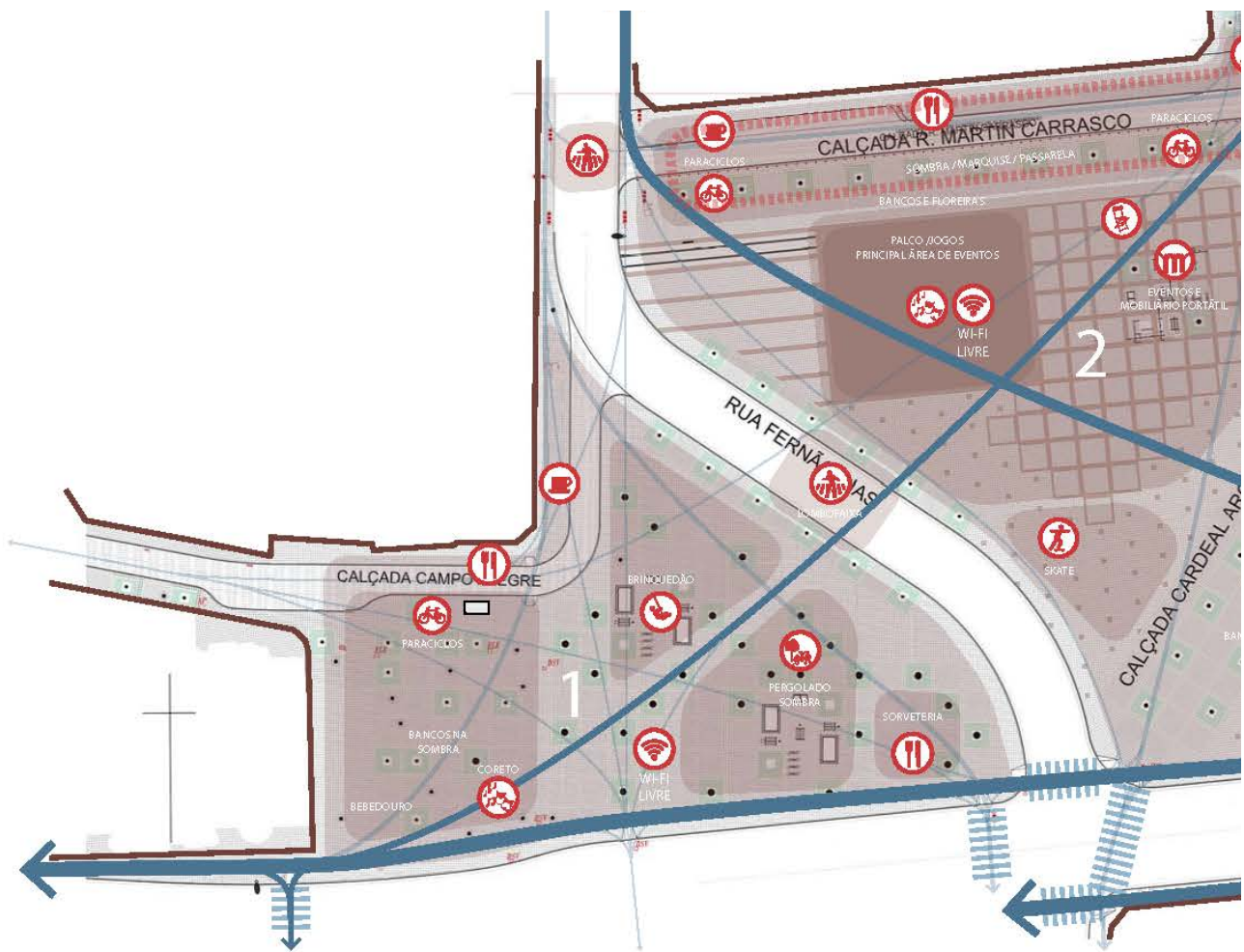

- Lazer para idosos
- Lazer para crianças
- Bancos
- Redário

- Infraestrutura (água e energia)
- Paraciclos
- Quiosque com sanitários



ZONA IGREJA

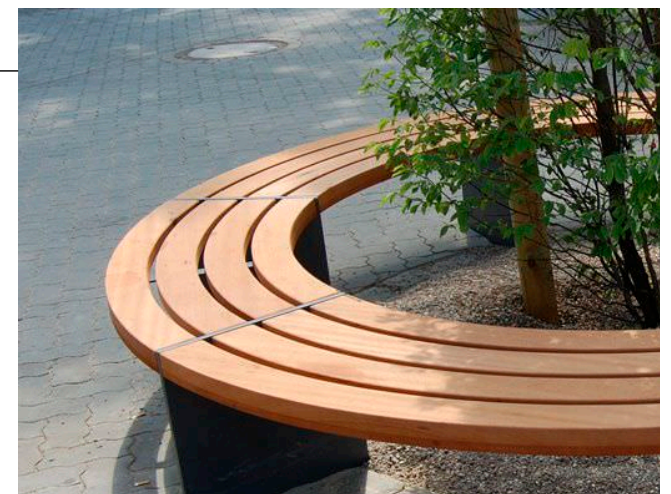

ZONA IGREJA



BANCO DE CONCRETO

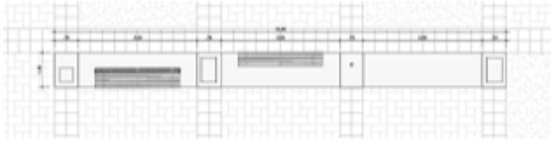
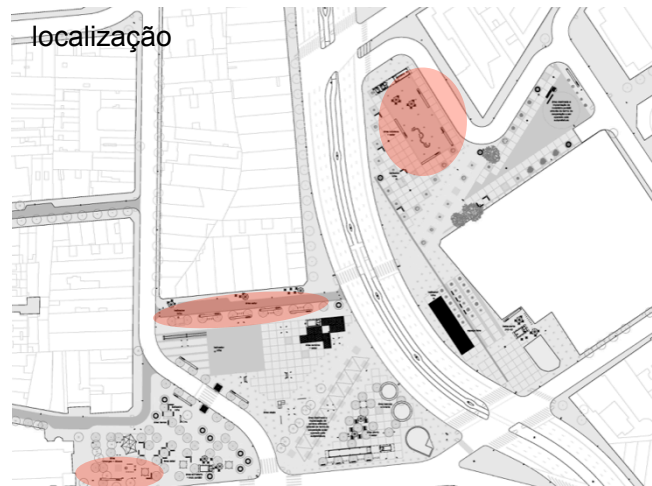

BANCO EM CONCRETO COM ASSENTO EM MADEIRA
PLANTA - ARTICULAÇÃO DE MÓDULOS
ESCALA 1:10



BANCO EM CONCRETO COM ASSENTO EM MADEIRA
ELEVADO - ARTICULAÇÃO DE MÓDULOS
ESCALA 1:10

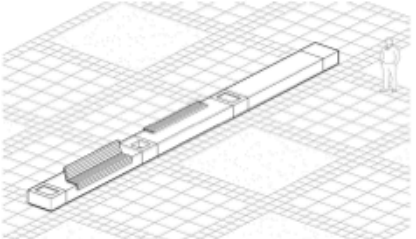

BANCO EM CONCRETO COM ASSENTO EM MADEIRA
ISOMÉTRICA - ARTICULAÇÃO, EXEMPLO 1
ESCALA 1:10

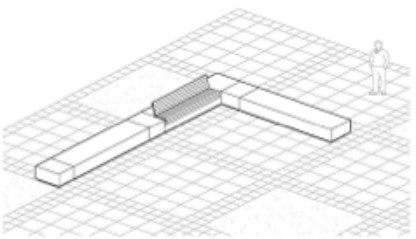

BANCO EM CONCRETO COM ASSENTO EM MADEIRA
ISOMÉTRICA - ARTICULAÇÃO, EXEMPLO 2
ESCALA 1:10

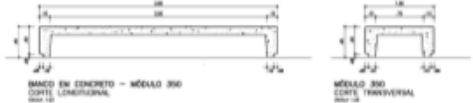

BANCO EM CONCRETO - MÓDULO 300
CORTE LONGITUDINAL
ESCALA 1:10

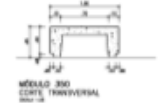

MÓDULO 300
CORTE TRANSVERSAL
ESCALA 1:10

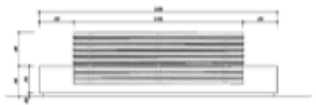

MÓDULO 300
ELEVADO FRONTAL
ESCALA 1:10



MÓDULO 300
CORTE TRANSVERSAL
ESCALA 1:10

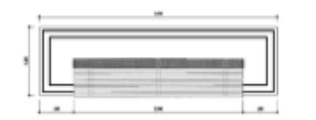

BANCO EM CONCRETO COM ASSENTO
EM MADEIRA
PLANTA
ESCALA 1:10

BANCO EM CONCRETO COM ASSENTO EM MADEIRA - MÓDULO 300 - 0,70m DE ALTEZURA TOTAL (0,40m DE CONCRETO + 0,30m DE MADEIRA).
A PARALAS DO PISO EXISTENTE AO LADO DO BANCO DEBORA E BARRIGADA INTERNA.
BANCO DE MADEIRA COM O SEU SACOÇO INTERIOR DE 400x100x40 mm.
O MÓDULO DE 0,70m APRESENTA ANOSOS PARA O PISO DE PLÁSTICO, INCLINADO 2°.

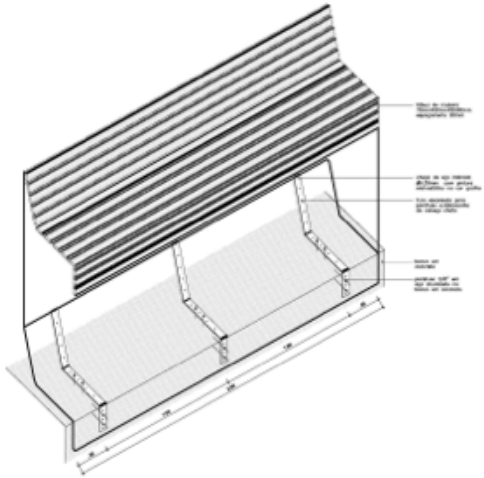

ESQUEMA DE MONTAGEM DO BANCO - ISOMÉTRICA
ESCALA 1:10
O BANCO É FORMADO POR MÓDULOS DE 0,70m DE ALTEZURA TOTAL (0,40m DE CONCRETO + 0,30m DE MADEIRA).
O MÓDULO DE 0,70m APRESENTA ANOSOS PARA O PISO DE PLÁSTICO, INCLINADO 2°.

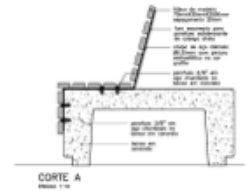

CORTE A
ESCALA 1:10
BANCO EM CONCRETO COM ASSENTO EM MADEIRA - MÓDULO 300 - 0,70m DE ALTEZURA TOTAL (0,40m DE CONCRETO + 0,30m DE MADEIRA).
A PARALAS DO PISO EXISTENTE AO LADO DO BANCO DEBORA E BARRIGADA INTERNA.
BANCO DE MADEIRA COM O SEU SACOÇO INTERIOR DE 400x100x40 mm.
O MÓDULO DE 0,70m APRESENTA ANOSOS PARA O PISO DE PLÁSTICO, INCLINADO 2°.



BANCO - ISOMÉTRICA
ESCALA 1:10
O BANCO É FORMADO POR MÓDULOS DE 0,70m DE ALTEZURA TOTAL (0,40m DE CONCRETO + 0,30m DE MADEIRA).
O MÓDULO DE 0,70m APRESENTA ANOSOS PARA O PISO DE PLÁSTICO, INCLINADO 2°.



QUIOSQUE COM SANITÁRIOS

Construído com as mesmas características do bicicletário

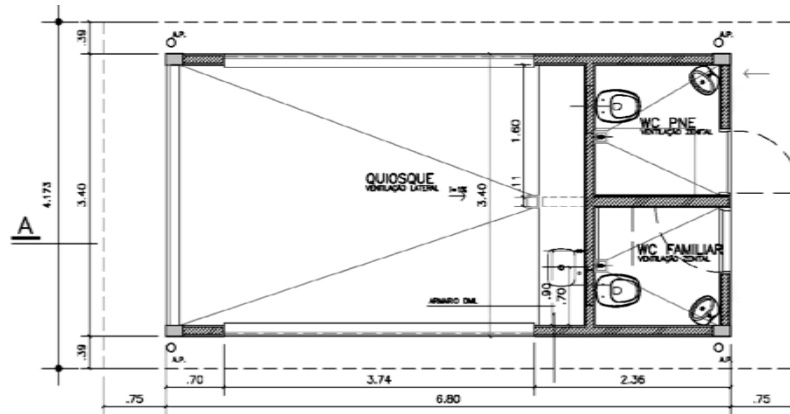

AMPLIAÇÃO - SANITÁRIO E QUIOSQUE
PLANTA
ESCALA 1/50

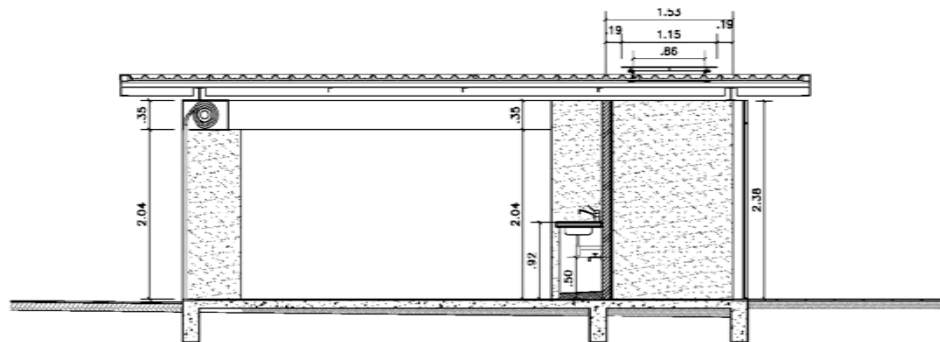

AMPLIAÇÃO - SANITÁRIO E QUIOSQUE
CORTE AA
ESCALA 1/50

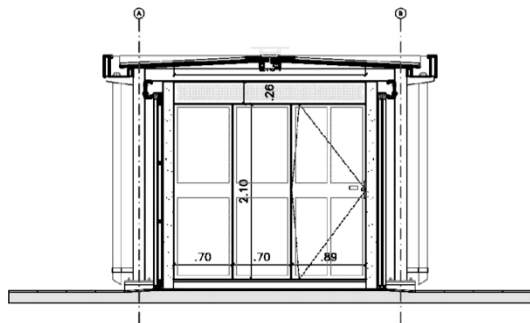

AMPLIAÇÃO - SANITÁRIO E QUIOSQUE
CORTE BB
ESCALA 1/50

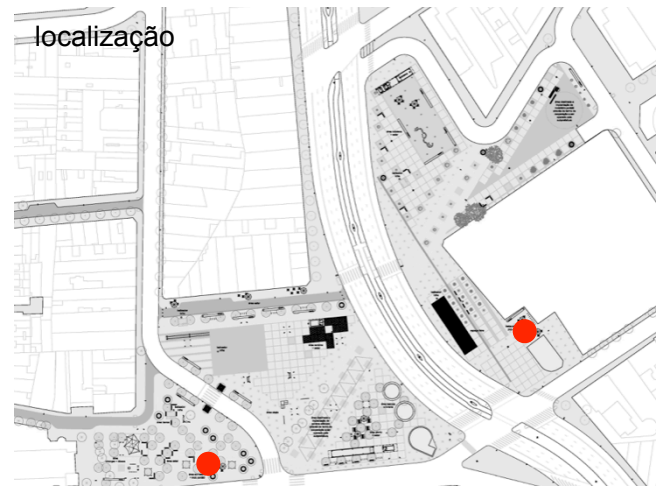

ZONA ARAUCÁRIAS E MERCADO

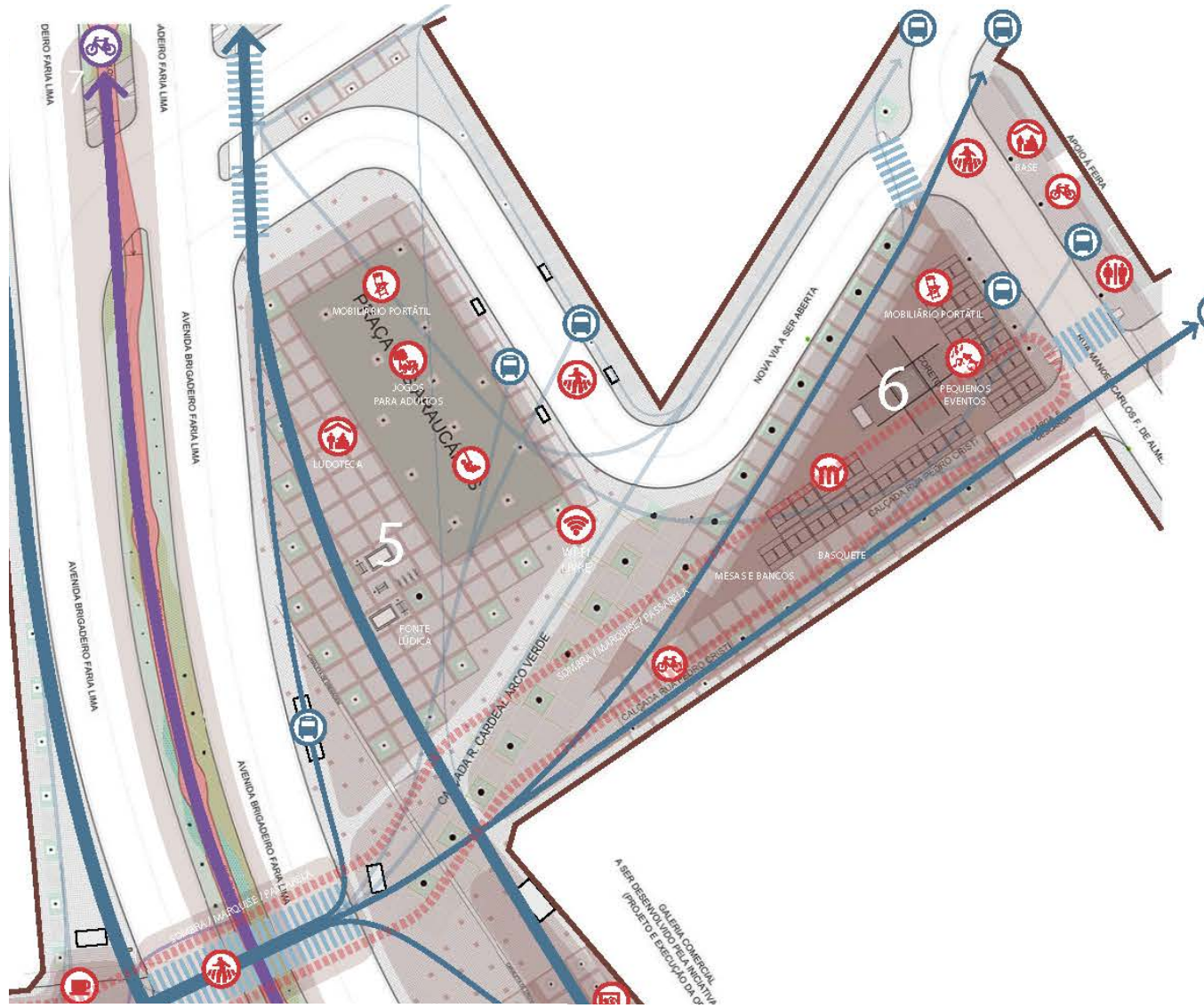

- Estar e descanso
- Lazer para crianças
- Bancos
- Mobiliário portátil
- Infraestrutura (água e energia)
- Ludoteca e sanitários



ZONA ARAUCÁRIAS E MERCADO

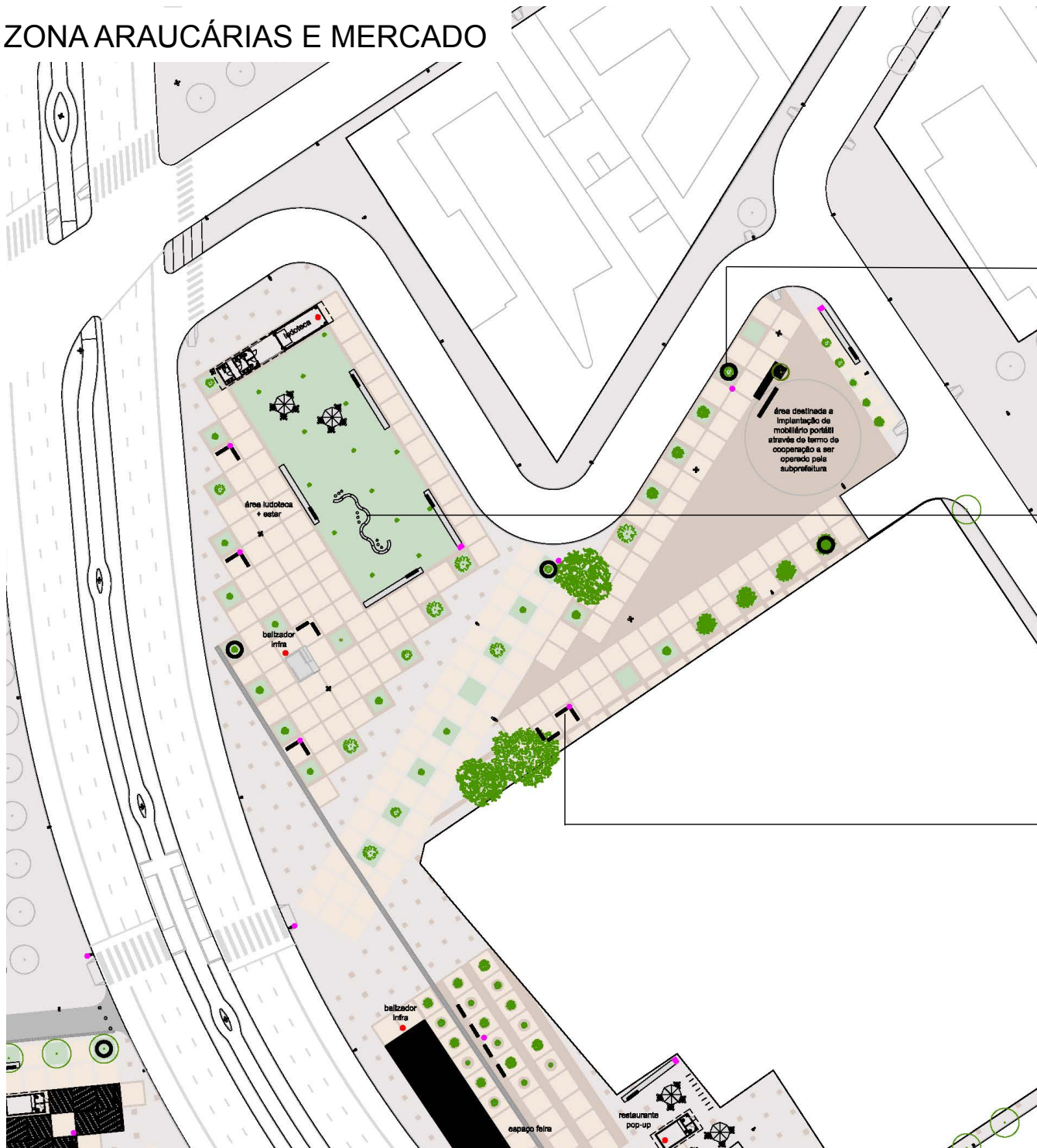

BANCO ILHA

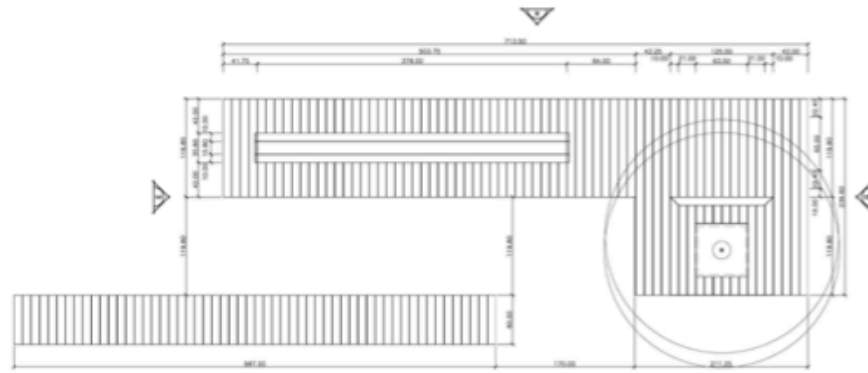

INPLANTAÇÃO DO BANCO ILHA
ESCALA 1/20
MEDIDAS EM CM

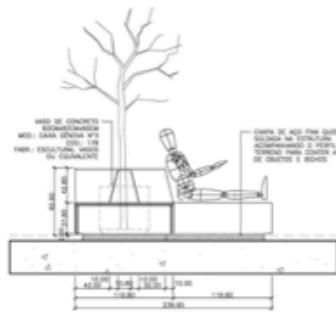

VISTA E
ESCALA 1/20
MEDIDAS EM CM

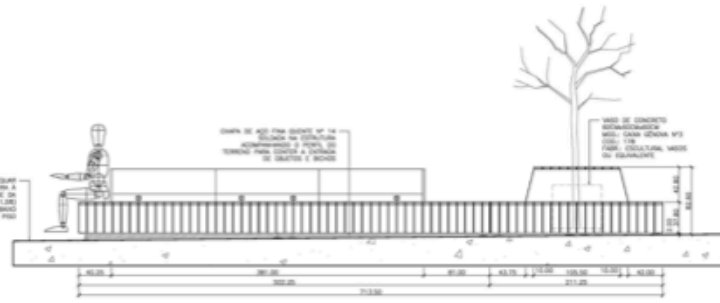

VISTA F
ESCALA 1/20
MEDIDAS EM CM

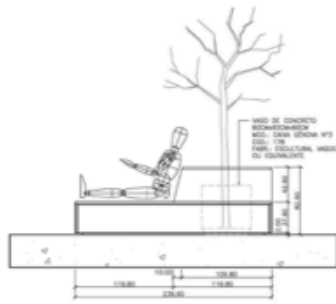

VISTA G
ESCALA 1/20
MEDIDAS EM CM

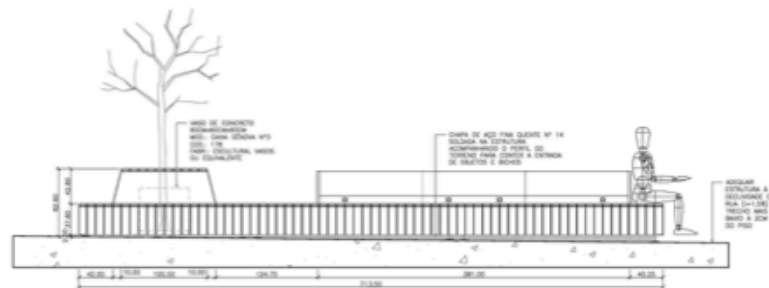

VISTA H
ESCALA 1/20
MEDIDAS EM CM

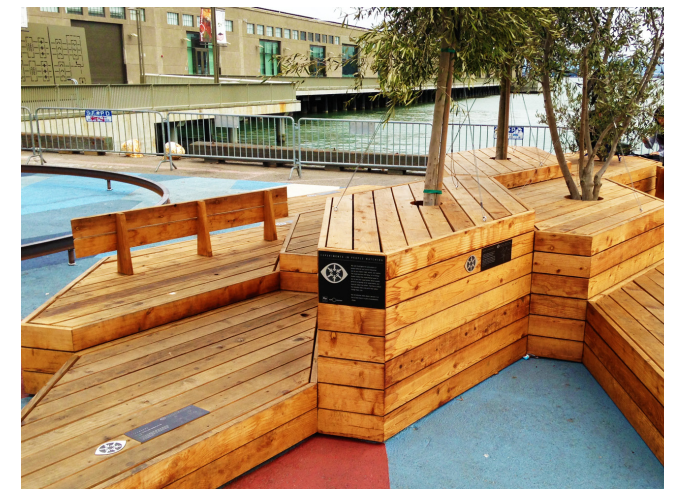
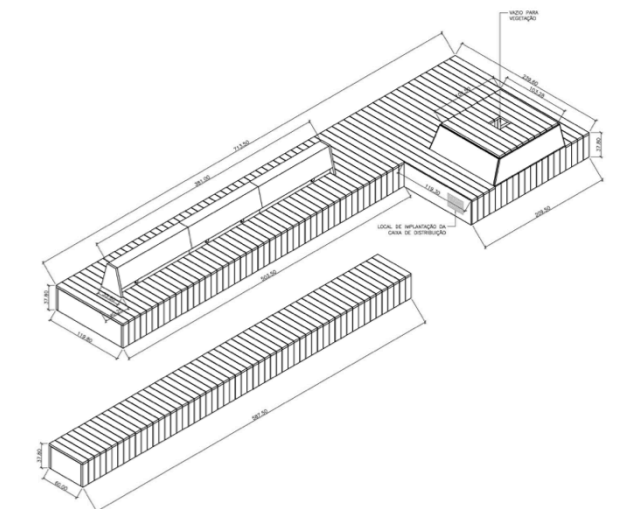

LUDOTECA / RESTAURANTE POP-UP E SANITÁRIOS

Construído com as mesmas características do bicicletário

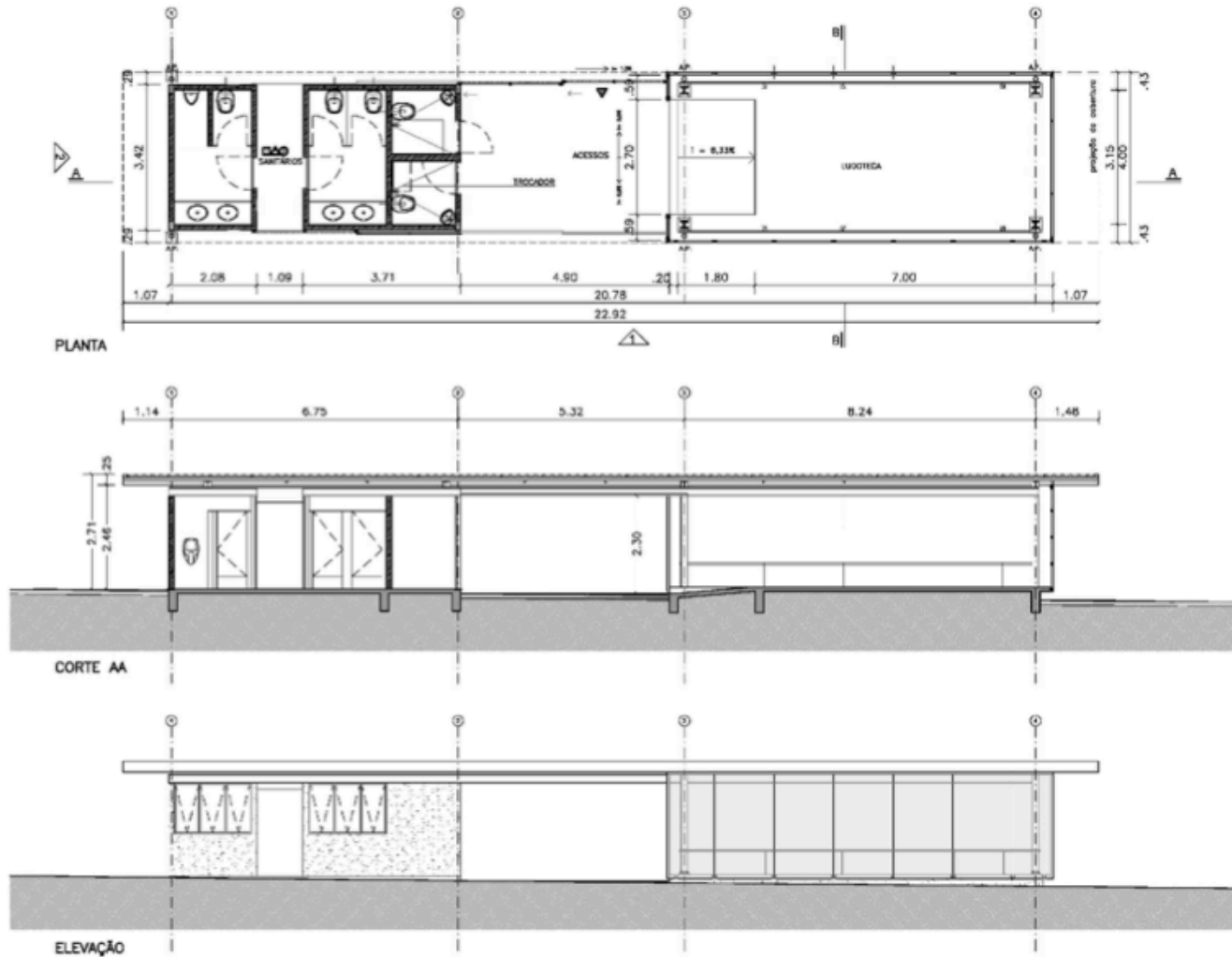

ZONA EM FRENTE A “CAC”

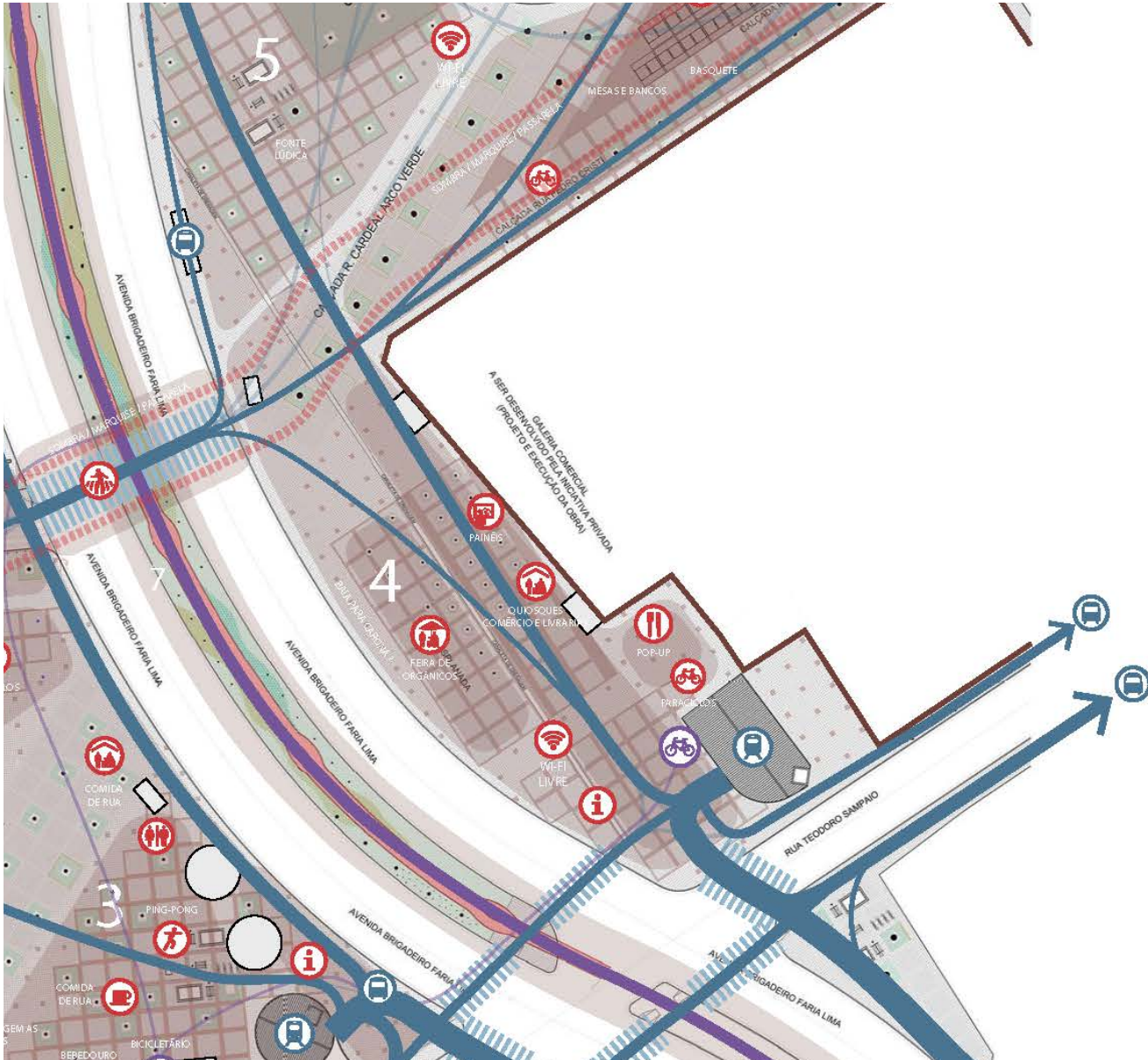

- Feira orgânica
- Bancos
- Quiosque e sanitários
- Mobiliário portátil

- Infraestrutura (água e energia)
- Paraciclos

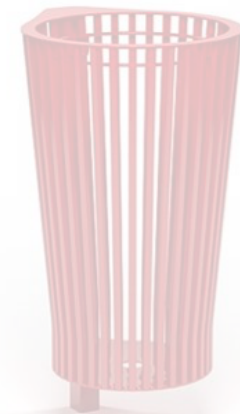

ZONA EM FRENTE A "CAC"

